



Schueco Premium Partner
"Certified for 11 Consecutive Years"

DIVERSITY FORM VARIETY

MODERN façades

ENERGY EFFICIENCY

*2300

Vision of the Polatoglu is to be at every point of construction sector



GREEN FAÇADES



SLIDING DOORS



WINDOWS & DOORS



BALUSTRADES



ALUMINIUM COMPOSITE PANELS



GFRC / FIBER CONCRETE WALLS



TERRAZZO WALL PANELS



THERMAWOOD FAÇADE CLADDING



0023-EP

ESTABLISHED 2009

control

20
26

WE ARE

an aluminium facade company
Vision of the Polatoglu is to be at every point of construction sector

02

ABOUT US

WHO WE ARE

Polatoglu Metal was established in Istanbul in 2016 and has earned a strong reputation through integrity, technical expertise, and reliable project execution. With roots built on years of international sector experience, the company has developed into a trusted solution partner for façade, architectural, and construction projects.

Backed by an experienced and dynamic team, Polatoglu Metal combines engineering knowledge, production capability, and on-site execution under one structure. From concept development to final installation, the company delivers quality, speed, precision, and professional coordination at every stage of its operations.

Through a commitment to continuous improvement, modern technology, and customer-focused service, Polatoglu Metal continues to create long-term value for investors, contractors, architects, and developers.

REGIONAL EXPERIENCE

In addition to its operations in Türkiye, Polatoglu Metal has been actively operating in **Baku since 2009**. Starting with the Central Clinic Hospital (Mərkəzi Klinika Xəstəxana) project, the company has successfully completed numerous residential, commercial, hospitality, and public developments. Today, it works with leading contractors and investors across Azerbaijan.

PRODUCTION POWER

The company's production facility in Baku includes **1,000 m² indoor and 1,000 m² outdoor** operational area, supported by more than **100+ personnel**. Production and installation activities include **aluminium façades, doors and windows**, composite cladding, compact laminate systems, automatic doors, **GFRC systems, terrazzo panels**, thermowood, **marble, ceramic cladding**, railings, sunshades, steel structures, and bespoke architectural metal works.

DIGITAL ENGINEERING & FREE-FORM SOLUTIONS

Polatoglu Metal holds advanced expertise in **GFRC** façade systems and complex free-form architectural applications. Architectural concepts are professionally developed through **Rhinoceros 3D**, optimized through engineering processes, and converted into production-ready **CAD** data.

Using advanced 8-axis robotic CNC machining centers capable of processing EPS / polystyrene blocks, the company manufactures highly accurate molds for complex geometries, double-curved surfaces, parametric forms, and custom architectural elements. This integrated workflow enables innovative designs to be transformed into precise and buildable reality.

ENGINEERING PRECISION

Every project is managed with detailed engineering review, accurate shop drawings, coordinated production planning, and disciplined site execution.

Façade systems are developed to meet architectural intent, structural requirements, and long-term performance expectations. By combining technical planning with practical installation experience, Polatoglu Metal ensures smooth project delivery from concept to completion.

STRATEGIC GROWTH

As of 2026, Polatoglu Metal proudly marks its **11th consecutive year** as an official **Schüco Premium Partner** reflecting long-term trust and technical excellence..

In line with its regional growth vision, the company has initiated preparations to expand into **Dubai** and aims to begin active operations in the near future.

ENGINEERING COMMITMENT

Driven by engineering excellence, precision manufacturing, and attention to detail, Polatoglu Metal continues to deliver reliable, innovative, and long-lasting building solutions.



CERTIFICATE

a decade of trust, 11 years certified with Schüco
Vision of the Polatoğlu is to be at every point of construction sector

03

SCHÜCO

Sertifika

Polatoğlu; Schüco Alüminyum Kapı, Pencere ve Cephe Sistemleri ile çözümler sunabilecek ve Schüco standartlarında uygulamalar yapabilecek niteliklere sahip bir SCHÜCO PARTNER'idir.



Polatoğlu Metal A.Ş.
Binagadı, Baksol Arazisi 1
Baku/Azərbaycan

Tel: 00994124125323

Web: www.polatoglu.org

POLATOĞLU

- Polatoğlu, Schüco Partner olma kriterlerine sahip bir firma olarak Schüco sistemlerini kullanmaktadır.
- Polatoğlu, müşterilerine verdiği tavsiyelerde, iş planlamalarında ve uygulamalarında Schüco sistem felsefesi ile hareket etmektedir.
- Firma yetkilileri Schüco Alüminyum Kapı, Pencere ve Cephe Sistemleri ile çözüm üretilmesi ve uygulaması konularıyla ilgili eğitim görmüşlerdir.
- İşbu belge hiçbir hal ve şartta değiştirilemez, üzerinde oynama yapılamaz.

2026

İstanbul, 01.01.2026
Geçerlilik Tarihi: 31.12.2026

Can Eren
Genel Müdür



REFERENCES

aluminium facade company
Vision of the Polatoglu is to be at every point of construction sector

04

BAKU AQUATICS CENTRE



PROJECT DETAILS

Architect: Pujol Arquitectura in Barcelona

Location: Baku / Azerbaijan

Contractor: DDLAR GROUP

Fabricator: Polatoglu Metal Co. Inc.

System: Schueco

Completed: April 2015

Total Square Footage: 20,500 m²

Quantities

Aluminium Silicone Systems 7940 m²

Aluminium ACP - Door & Window Systems 2060 m²

Stainless Steel 316L Balustrade Systems 4500 m²

Steel Construction Works 1500 ton

Built as one of the flagship structures of the 2015 European Games, Baku Aquatic Center features a high-performance façade by Polatoglu Metal using Schüco systems, complemented by premium 316L stainless steel railing solutions.



BAKU SHOOTING CENTER



PROJECT DETAILS

Location: Baku / Azerbaijan

Contractor: DDLAR GROUP

Fabricator: Polatoglu Metal Co. Inc.

System: Schueco FWS 50 SG - AD UP DS

System: Compact Laminate

Glass: Guardian Glass

Completed: September 2015

Total Square Footage: 25,580 m2

“One of Europe’s largest shooting complexes, this prestigious project’s entire exterior façade was completed by Polatoglu Metal using Schüco systems”



BAYILBAY RESIDENCE



PROJECT DETAILS

Architect: Mauro Lipparini Architecture in Florence

Location: Baku / Azerbaijan

Contractor: DDLAR GROUP

Fabricator: Polatoglu Metal Co. Inc.

System: Schueco

Completed: April 2019

Total Square Footage: 26,550 m²

Quantities

Schueco Aluminium Covered Facade Systems 8000 m²

Schueco Aluminium Sliding Doors 2500 m²

Mitsubishi Alpolic Aluminium CPS 6000 m²

Aluminium Door & Window Systems 850 m²

Ceramic Cladding 5500 m²

Steel Construction Works 1500 ton / 3700m²

The exterior façade of Bayilbay Building in Baku was engineered and completed by Polatoglu Metal using advanced Schüco systems, delivering precision, durability, and modern architectural performance.



REFERENCES

aluminium facade company
Vision of the Polatoglu is to be at every point of construction sector

07

VICTORY PARK BAKU



PROJECT DETAILS

Location: Baku / Azerbaijan

Contractor: PMD Projects

Fabricator: Polatoglu Metal Co. Inc.

Completed: 8 November 2024

Total Square Footage: 3,200 m²

Quantities

GFRC Fiber Concrete Louvre Panels 3.200 m²

GFRC Fiber Concrete Seats 3500 meters

Heavy Steel Structure 120 tone

Victory Park, dedicated to the martyrs of Azerbaijan and completed in 2024, was created as a sacred memorial park. The project's complex free-form GFRC precast panels were proudly produced by Polatoglu Metal.



REFERENCES

aluminium facade company
Vision of the Polatoglu is to be at every point of construction sector

08

SABAH RESIDENCE BAKU



PROJECT DETAILS

Location: Baku / Azerbaijan

Contractor: Qala Group

Fabricator: Polatoglu Metal Co. Inc.

Completed: December 2023

Total Square Footage: 20,123 m²

Quantities

Aluminium Profiles Systems 16.800 m²

Aluminium Composite Panel Systems 1.100 m²

Sinterflex Curtain Wall & Aqua Panel 11.123 m²

“One of the most prestigious residential projects in Baku, Sabah Residence, developed by Gala Group and located in the exclusive Bayil district, offers one of the city’s finest panoramic views, with all aluminium façade works completed by Polatoglu Metal”



GANJLIK RESIDENCE



PROJECT DETAILS

Location: Baku / Azerbaijan
Contractor: DDLAR GROUP
Fabricator: Polatoglu Metal Co. Inc.
Completed: July 2016
Total Square Footage: 22,500 m²

Quantities

Aluminium Door & Window Systems 8550 m²
Aluminium Composite Panel Systems 12400 m²
Steel Construction Works 120 ton / 1550m²

“Located in the prominent Ganjlik area of Baku, this modern residence project commissioned by the Ministry of Youth and Sports features full façade solutions executed by Polatoglu Metal”



REFERENCES

aluminium facade company
Vision of the Polatoglu is to be at every point of construction sector

10

PORT BAKU WALK WAY GARDEN



PROJECT DETAILS

Location: Baku / Azerbaijan
Contractor: North West Construction
Fabricator: Polatoglu Metal Co. Inc.
Completed: February 2024
Total Square Footage: 23,350 m²

"A pioneering project in Baku, Port Baku Walkway Garden introduced the first-ever terrazzo exterior panel system to the city, successfully engineered and delivered by Polatoglu Metal despite its highly complex execution requirements.



BRAVO NGA HYPERMARKET



PROJECT DETAILS

Location: Baku / Azerbaijan

Contractor: Pasha Construction

Fabricator: Polatoglu Metal Co. Inc.

Completed: October 2018

Total Square Footage: 22,430 m²

Quantities

Aluminium Covered Facade Systems 3500 m²

Aluminium Composite Panel Systems 8500 m²

Aluminium Door & Window Systems 250 m²

Ceramic Cladding 500 m² / Automatic Door Systems 80 m²

Thermowood Works 500 m²

Glass Balustrade Systems 1500 m²

Aluminium Mesh Panel Systems 6000 m²

Aluminium Panel Systems 1600 m²

Awarded by Pasha Construction, the NGA Bravo Hypermarket project was successfully delivered by Polatoglu Metal with a modern and durable façade solution.



SEA BREEZE ORLOV VILLAS / BATH



PROJECT DETAILS

Location: Sea Breeze Baku / Azerbaijan

Contractor: Sea Breeze Construction

Fabricator: Polatoglu Metal Co. Inc.

Completed: 23 March 2026

Total Square Footage: 13,209 m²

Quantities

Thermal Insulation (EIFS) Works: 4,400 m²

Roof Waterproofing Works: 3,000 m²

Aluminum Sliding Systems: 700 m²

Aluminum Façade Works: 509 m²

Aluminum Composite Panel Cladding: 3,200 m²

Thermowood Limba Cladding: 8,000 mt

Thermowood Decking: 800 m²

Corten Steel Works: 600 m²

“Situated within the premium Sea Breeze coastal district, the Orlov Villas and Bath Complex had all exterior cladding and façade works successfully completed by Polatoglu Metal.”



PROJECTS

aluminium facade company
Vision of the Polatoglu is to be at every point of construction sector

13

LIGHTHOUSE SEA BREEZE RESIDENCE



PROJECT DETAILS

Location: Baku / Azerbaijan

Contractor: Terra Struc

Fabricator: Polatoglu Metal Co. Inc.

Completed: September 2019

Total Square Footage: 5,470 m²

“As one of the earliest signature developments of the Sea Breeze area, Lighthouse Residence had its full exterior façade scope completed by Polatoglu Metal with premium quality standards.”



PROJECTS

aluminium facade company
Vision of the Polatoglu is to be at every point of construction sector

14

BRAVO MARKET 20 YANVAR BRAO MARKET AIRPORT



PROJECT DETAILS

Location: Baku / Azerbaijan

Contractor: Uni Const.

Fabricator: Polatoglu Metal Co. Inc.

Total Square Footage: 6,560 m2



PROJECT DETAILS

Location: Baku / Azerbaijan

Contractor: North West Const.

Fabricator: Polatoglu Metal Co. Inc.

Completed: March 2019

Total Square Footage: 3,223 m2



PROJECT DETAILS

Location: Baku / Azerbaijan

Contractor: AGT Construction

Fabricator: Polatoglu Metal Co. Inc.

Completed: August 2017

Total Square Footage: 8,380 m2



BAKI PLAZA SUMQAYIT



PROJECT DETAILS

Location: Sumgayit / Azerbaijan

Fabricator: Polatoglu Metal Co. Inc.

System: Schueco

Completed: September 2023

Total Square Footage: 5,500 m²

Quantities

Aluminium Silicone Systems 3.450 m²

Aluminium Sliding Door Systems 150 m²

Aluminium Composite Panel Systems 800 m²

PU sandwich panel 1100m²

A symbol of modern architecture, [Baki Plaza Sumgayit](#) features an exterior façade completed by Polatoglu Metal with Schüco systems.



PROJECTS

aluminium facade company
Vision of the Polatoglu is to be at every point of construction sector

16

PROJECT PORTFOLIO



SCANDENS PI PROJECT DETAILS

Location: Baku / Azerbaijan
Contractor: PMD Projects
Fabricator: Polatoglu Metal Co. Inc.
Completed: March 2023
Total Square Footage: 2,643 m²



CENTRAL CLINIC HOSPITAL PROJECT DETAILS

Location: Baku / Azerbaijan
Contractor: Yüksel İnşaat Ltd
Fabricator: Polatoglu Metal Co. Inc.
Completed: June 2010
Total Square Footage: 2,661 m²



KHUDAT AGRO CENTER PROJECT DETAILS

Location: Khudat / Azerbaijan
Contractor: Uni Construction
Fabricator: Polatoglu Metal Co. Inc.
Completed: June 2023
Total Square Footage: 2,661 m²



PROJECT PORTFOLIO



GABALA MILK FACTORY **Administration & Showroom Building**

PROJECT DETAILS

Location: Gebele / Azerbaijan

Fabricator: Polatoglu Metal Co. Inc.

Completed: August 2012

Total Square Footage: 1,020 m²



DREAMLAND MALL

PROJECT DETAILS

Location: Baku / Azerbaijan

Contractor: Azersun

\Fabricator: Polatoglu Metal Co. Inc.

System: Skylight Roof

Completed: August 2018

Total Square Footage: 1450 m²



PROJECT PORTFOLIO



OFFICE BUILDING OF STAR CEMENT

PROJECT DETAILS

Location: Sumqayit / Azerbaijan
Contractor: Star Cement Plant
Fabricator: Polatoglu Metal Co. Inc.
Completed: March 2015
Total Square Footage: 1,815 m²



LINK BUILDING OF CRYSTAL HALL

PROJECT DETAILS

Location: Baku / Azerbaijan
Contractor: DDLAR GROUP
Fabricator: Polatoglu Metal Co. Inc.
System: Schueco
Completed: April 2015
Total Square Footage: 2,930 m²



SHOOTING CENTER BAKU HOTEL BUILDING

PROJECT DETAILS

Location: Baku / Azerbaijan
Contractor: DDLAR GROUP
Fabricator: Polatoglu Metal Co. Inc.
System: Schueco
Completed: April 2015
Total Square Footage: 1,718 m²



SG PALACE BILGEH

PROJECT DETAILS

Location: Baku / Azerbaijan
Contractor: Private
Fabricator: Polatoglu Metal Co. Inc.
System: Schueco
Completed: April 2016
Total Square Footage: 759 m²



PROJECT PORTFOLIO



VOLKSWAGEN SHOWROOM BAKU

PROJECT DETAILS

Location: Baku / Azerbaijan
Contractor: North West Construction
Fabricator: Polatoglu Metal Co. Inc.
Completed: 2019
Total Square Footage: 2,150 m²



DREAMLAND MALL

PROJECT DETAILS

Location: Baku / Azerbaijan
Contractor: Azersun Holding
Fabricator: Polatoglu Metal Co. Inc.
Completed: April 2016
Total Square Footage: 3,500 m²



THE CLUB PORT BAKU

PROJECT DETAILS

Location: Baku / Azerbaijan
Contractor: Pasha Construction
Fabricator: Polatoglu Metal Co. Inc.
Completed: April 2017
Total Square Footage: 1,881 m²



QAZAX TEACHERS SEMINARY

PROJECT DETAILS

Location: Qazax / Azerbaijan
Contractor: Ada Universiteti
Fabricator: Polatoglu Metal Co. Inc.
Completed: April 2023
Total Square Footage: 2,760 m²



WINDOWS & DOORS

HIGH ENERGY EFFICIENCY PERFORMANCE

Do not compromise on the insulation for your home. Windows guarantee you maximum energy efficiency. This is how you ensure markedly lower heating costs. You can make further savings with targeted ventilation. Here too, Schueco has the right solution.

OPTIMUM INSULATION LEVELS

Do not compromise on the insulation for your home. Windows guarantee you maximum energy efficiency. This is how you ensure markedly lower heating costs. You can make further savings with targeted ventilation. Here too, Schueco has the right solution.

ENVIRONMENTAL & COST BENEFITS

For a family home with a surface area of 143.8 m² and a window area of 26.4 m², which was constructed in about 1980 there would be, a saving of 51 kWh/(m²a) or 730 litres of heating oil per year. The consumption of 730 litres less oil reduces CO₂ emissions by two tonnes per year. This corresponds to a journey of about 10,000 km by car or a Co₂ volume of 1250 m³).

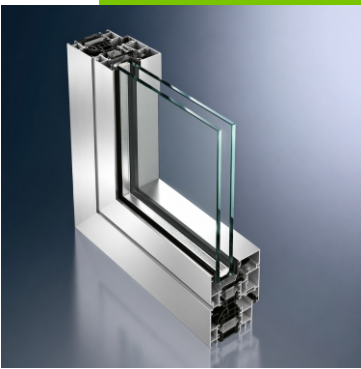

70.HI - Highly thermally insulated aluminium window system.

Window combines efficient solutions for a wide variety of functional, architectural and design requirements in one system: a high level of thermal insulation, narrow face widths and attractive vent contours as well as concealed, classic manual or integrated electromechanical fittings for inward and outward-opening windows.

Uf value of 1.6 W/(m²K) with a face width of 117 mm

SLIDING SYSTEMS

ADVANCED SLIDING SYSTEM EXPERIENCE

Our company has proven engineering experience in high-performance sliding systems designed for demanding wind load conditions while maintaining excellent thermal insulation and energy efficiency. For a recent project, we successfully developed and proceeded with the Schüco ASE 60 sliding system based on a design wind load requirement of 4.0 kN/m².

Through detailed engineering studies, profile reinforcement evaluations, glass calculations and system optimisation, the required performance criteria were achieved and supported with technical documentation and test reports. Together with high-quality insulating glass and thermally broken aluminium profiles, the system provides excellent indoor comfort, reduced energy consumption and reliable long-term performance. This experience demonstrates our capability to deliver secure, efficient and high-performance sliding solutions even for challenging façade conditions.



70.HI lift-and-slide door

The aluminium profiles, which are thermally broken by insulating bars, are fitted with isolators and efficient gaskets.

Together with high quality insulating glass, the best thermal insulation results are achieved.

The ASS 70.HI lift-and-slide door therefore fulfills the requirements of EnEV with ease.

ENERGY EFFICIENCY



ALUMINIUM PANEL FACADE SYSTEMS

The building shell made with aluminum curtain wall systems is to be formed by a modular technique. All the components forming the panel facade modules are converted into finished products in the controlled factory environment and assembled at the site site.

Advantages of panel façade application

High quality product

Quick mounting possibility

The water extraction and ventilation items have been solved and tested in the system.

The independence and technical performances of the sample prepared according to the relevant standards of air, water impermeability and wind resistance tests, the samples with international Qualanod and Qualicoat surface treatment certificates, all system materials supported with 10 years liability insurance, Systems that can be tested in an approved and approved test center.

Aluminum Covered Panel Facade Systems

Aluminum, Structural Silicone Panel Facade Systems

Aluminum Semi-Lid (Two Side) Panel Facade Systems

Aluminum Cascade Panel Facade Systems



STRUCTURAL SILICONE FACADE SYSTEMS



Feature of the silicone facade systems is that from outside aluminum profiles are invisible and only used glasses and 15mm joints between glasses are visible. There are silicone sealant between panels, as space between glasses panels are provided with Epdm sealing gaskets. According to the structure of the building, geographical region and climatic conditions, used profiles can again heat insulation properties as a barrier system.

SEMI – STRUCTURAL FACADES

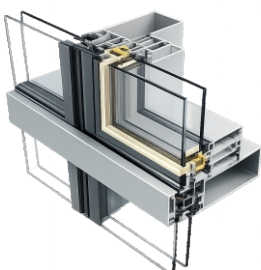

Structural (silicone) facades are visible structure and no distinctive difference between the external opening and unopened portion. The joint between the glass is filled with rubber or silicone seal. Typical of the structural performance of the facade is that exterior glazing with glass bearing is affixed by a special silicone to aluminum tape, whereby the assembly is on aluminum supporting structure of the facade. Systems of this type of walls allow light assembly and disassembly of glazing which, combined with elegant design of new buildings, makes it the preferred option for façade solution.

Semi- structural facades are glass with frame of aluminium profile which are hung on pre-assembled column and beam.

SKYLIGHT ROOFING SYSTEMS

Skylight systems due to the feature of reinforced steel can easily pass the distance. Skylight system has structure to take out both condensation and water leakage in system and condensation water, that can occur on the inside glass surface due to the condenser channels in the bracket profile. In skylight system it is possible to put wings opening in every position, to equip this wings with motor mechanisms and by sensor or manually ventilation and smoke extraction can be performed automatically.

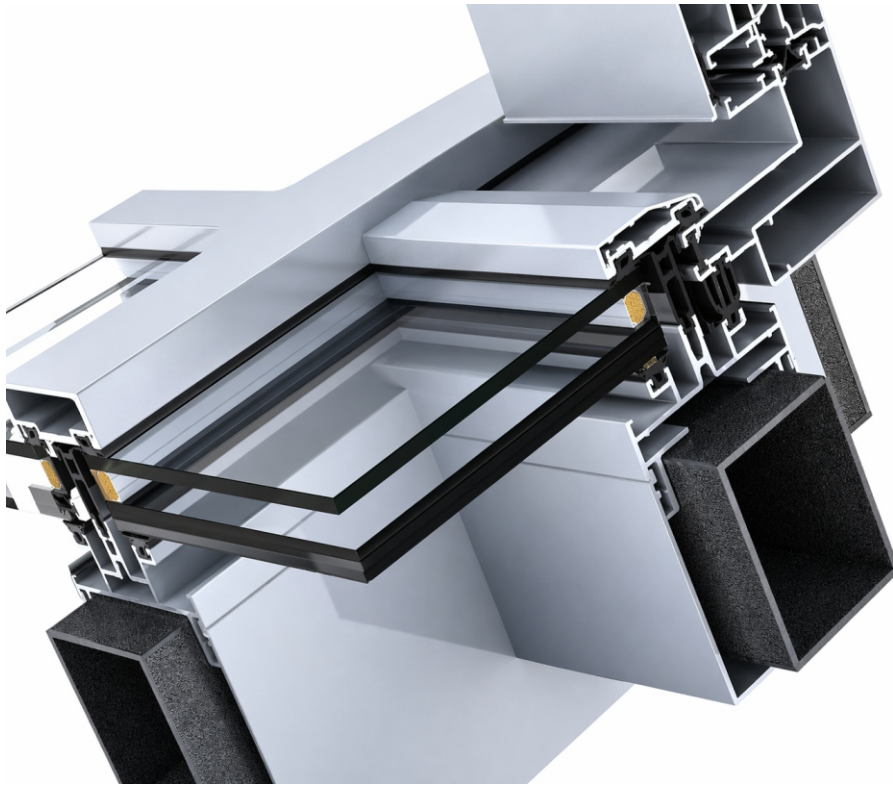

- Designed to create bright spaces using natural light.
- Can be applied with or without conduit channel.
- It can be applied with horizontal - vertical cover or horizontal silicone with vertical cover.
- Designed to accommodate large openings; Application and manufacturing is a practical system.
- There are alternatives to the inner cover that can be used to cover the steel substructures that carry the system.
- It is possible to apply glass and polycarbonate sheet.
- It is economical at the same time as it has a wide range of products.



OFFICE PARTITIONING SERVICES

Polatoglu offers partitioning services for residential and commercial facilities. We supply and install high quality glass partitions, MDF partitions, aluminium partitions, frameless glass partitions and demountable partitions.

Solid Partitions They are of two types:

Plasterboard panels: A single skin plasterboard panel, gives a 30-minute fire rating, and a double skin, which gives a 1 hour fire rating.

Composite panels: The composite panel is made with a 27mm honeycombed core and faced off with 9.5mm of plasterboard to either side. This type of panel is usually used in our demountable partitioning systems.

Glazed Demountable Partitions: This is an extremely versatile, non-load bearing, re-locatable partitioning system for internal use. Contained within a 50mm aluminium framework this system is light and durable.

Glazed partitions offer the ideal solution to your temporary or longer-term office requirements.

Made of aluminium or plastic sections to create single and double glazed modules, these panels can be faced in vinyl, melamine, veneer or steel and can be satin anodised or powder coated to any colour in the BS or RAL ranges.

The skirting can be made from plastic or aluminium from 75mm to 150 mm in height.

Glazed partitions are particularly useful if there is a need to maximise light or increase visibility in an office.



What are the benefits of using office partitioning over traditional building techniques?: The principal benefits of office partitioning over traditional building techniques are speed and flexibility. Partitions can be erected, demounted and re-erected very quickly and without the mess or noise disruption associated with other forms of re-modelling. In addition, in most cases, there is no need to close the office whilst the work is being carried out.

What choice of office partition finish is there? There is a choice of timber veneer, glass, vinyl steel or MFC (melamine faced composite). The decision on which material to use should be based upon its intended purpose

What choice of door finish is available?: You can choose a door finish from timber, veneer, glass, steel, or laminate.



GFRC Cladding Panels | 8-Axis CNC – Industrial Robot

Application Areas (Industries)

Aerospace: Machining composite parts, wing and fuselage prototypes. **Automotive Industry:** Clay modeling (design studios), machining large molds and forms. **Marine / Shipbuilding:** Boat hull molds, propeller machining. **Art & Sculpture:** Producing sculptures from large foam blocks or marble. **Construction:** Timber and GFRC structural elements, architectural models.

What Does the Term "Axis" Mean? (Basic Information)

Explanation: **3 Axes:** X, Y, Z (standard linear movement) **6 Axes:** Standard industrial robotic arm (includes rotation and tilt movements) **8 Axes:** 6-axis robot + 2 external axes (typically a linear track + rotary table / positioner)

Robotic Machining Center (8-Axis CNC – Industrial Robot) High-Precision and Flexible Manufacturing Solutions

GFRC panels are manufactured using advanced **Spray-Up** production technology. In this process, a specially formulated glass fiber reinforced cementitious mix is sprayed onto molds under controlled conditions, creating uniform and high-strength panels. The Spray-Up method provides lightweight performance, superior durability, reduced cracking risk, and precise production of complex geometries. This technology combines architectural freedom with high engineering performance in a single solution.

All **3D panel geometries** are developed using advanced parametric modeling software such as Rhinoceros (Rhino), enabling precise free-form surface design, dimensional control, and mold optimization. The finalized digital models are then converted into CAD/CAM production data and transferred directly to CNC-controlled robotic machining systems for mold fabrication. This fully integrated digital workflow ensures maximum accuracy, repeatability, efficient production processes, and a seamless transition from design concept to physical manufacturing.

1 GFRC PANEL (THICKNESS 30 mm)
2 ALUMINIUM VERTICAL MULLION
3 ALUMINIUM HORIZONTAL TRANSOM
4 STAINLESS STEEL ANCHOR BRACKET
5 ADJUSTABLE BRACKET
6 INSULATION (MINERAL WOOL)
7 STAINLESS STEEL FASTENER
8 STRUCTURAL WALL (CONCRETE)

MATERIAL SPECIFICATIONS			
NO	PART NAME	MATERIAL	SPECIFICATION
1	GFRC Panel	GFRC (Glass Fiber Reinforced Concrete)	EN 1170-4 / ASTM C1185
2	Aluminium Vertical Mullion	Aluminium Alloy	EN AW 6063-T5
3	Aluminium Horizontal Transom	Aluminium Alloy	EN AW 6063-T5
4	Stainless Steel Anchor Bracket	Stainless Steel (304)	AISI 304 / A2-70
5	Adjustable Bracket	Stainless Steel (304)	AISI 304
6	Insulation	Mineral Wool	EN 13162
7	Stainless Steel Fastener	Stainless Steel (304)	AISI 304
8	Structural Wall	Reinforced Concrete	--

FRONT ELEVATION
SCALE 1:20

PLAN VIEW (TYPICAL)
SCALE 1:10

VERTICAL SECTION
SCALE 1:5

8-AXIS CNC ROBOT – MOLD FABRICATION PROCESS

GFRC SPRAY-UP PRODUCTION METHOD

GFRP PANEL PROFILE
SCALE 1:5

HORIZONTAL SECTION
SCALE 1:5

PANEL JOINT DETAIL
SCALE 1:2

PROJECT GFRC CLADDING SYSTEM **DATE** 20.05.2024
DETAIL Custom Curved Panel System **DWG NO.** P-GFRC-CURV-001
DRAWN BY Engineering Department **UNITS** mm

NOTES:
Precision in Every Panel



MANUFACTURING FACILITY

aluminium facade company
Vision of the Polatoglu is to be at every point of construction sector

27

Vision of the Polatoglu
is to be at every point of
construction sector..



elumatec

DOUBLE MITRE SAW DG 104

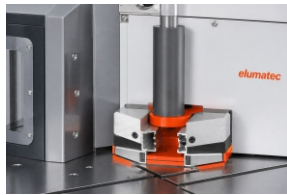

Description

The optimal double mitre saw for series production as well as for special applications
The universal pivoting and tilting of both saw units allows cutting of high and wide profiles as well as every type of compound mitre.
Consequently, many profiles can be cut without support blocks
External-dimension cuts possible for all cutting variants. Consequently, no complicated length calculations are necessary.
This is a big advantage when cutting special angles
Pivoting range with digital angle display
Safety hoods
Equipped with saw blades as standard
Equipped with digital display E 111 as standard
Pulsed coolant system

Technical specifications

Minimum cutting length at 90° 350 mm
Minimum cutting length tilted at 45° 350 mm
Pivoting range inwards 90° - 45°
(up to 22.5° manual with digital display)
Tilting range inwards pneumatically 90° - 45°
For cutting range, see cutting diagram
Saw blade diameter 420 mm
Saw blade speed 2,800 rpm
Power supply 230/400 V, 3~, 50 Hz
Power output per motor 4 kW
Compressed air supply 7 bar
Air consumption per working cycle 40 l without spraying, 64 l with spraying



elumatec

NOTCHING SAW AKS 134/00

Description

Variable notching possibilities for mullion and transom combinations, e.g. for curtain walls, conservatories, sky lights, and special designs. Precise and safe notching is ensured because the workpiece is fixed and only the saw units move. Both saw units are adjusted in height simultaneously by means of a hand wheel (analogue display on the hand wheel)

The cutting depth is set using an analogue display. Manual angle adjustment of the saw blades using a digital display of the tilting angles. Support table with compound slide and pivoting back fence is manually adjustable for optimal use of the cutting range. The angle of the pivoting back fence is shown on a digital display. Horizontal and vertical profile clamping.

Automatic working cycle at a 90° pivoting angle (two-hand control when cutting special angles) Hydro-pneumatic saw feed.

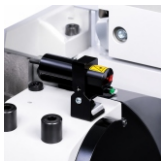

NOTCHING SAW AKS 134/10
See AKS 134/00, however:

Equipped with a 4-axis controller for automatic adjustment of the horizontal and vertical saw blades for angle cutting, as well as for height adjustment and notching depth. Values from design drawings can be entered directly via the keyboard.



elumatec**END MILLING MACHINE AF 223/01****Description**

For routing transoms and door profiles made of aluminium or PVC
 Large cutting range of up to 400 mm
 Continuously adjustable table height
 Automatic work sequence
 Tool diameters of up to 280 mm can be used
 The material stop can be pivoted up to 70° to the left and right.
 Notching up to 30° (acute angles, left and right). Detent at 90° with index pin.
 Two installation positions for the material stop
 With quick tool change system and "Spindle Lock" for easy tool changing
 Precise, smooth-action and low-wear recirculating ball guides
 Horizontal and vertical pneumatic material clamping provides flexibility
 Depth stop for four different notching depths
 Pulsed coolant system

Options

Extraction system
 4-fold turret stop for table height
 Digital display
 Router
 High performance cutting fluid

elumatec**CORNER CRIMPER EP-120****Description**

For pressing profiles with a height of up to 68 mm
 Extremely high pressing force due to large-volume bellows cylinder (maintenance free)
 The machine is easy to adjust and operate
 Counter bearing can be positioned pneumatically, mechanical locking
 Support arms and pressing blades included as standard

Options

Additional support
 Special pressing blade

SCHÜCO**ISOMAT 5 TAPPING & ROLLING MACHINE****ISOMAT 5**

For rolling the Schüco AWS and Schüco ADS system profile as well as special profiles and V8 components together with the insulating bars and for rolling down the angles on various profiles from the Schüco facade and skylight constructions.

We reserve the right to make changes to dimensions and designs in the interests of technical progress. Illustrations may differ from the original and/or contain options which would incur an additional charge.

Operating speed: 34m/min
Monitoring speed: -
Adjustment of rollers: different roller



nata CNC Alüminyum İşleme Makineleri

ND442L - PANEL 3 +1 AXIS CNC MACHINING



Description

CNC 3 + 1 axis milling, 3 axes (X, Y, Z) and tool change axis (C) are fully CNC controlled; Aluminum composite, aluminum profile, plexiglass, compact laminate and stainless steel panels on all kinds of joint opening, sizing, milling, drilling operations; All kinds of angular and circular processes are applied on the panels. It works with standard 2D CAD CAM graphics and optimization software, but instead of this software, 3D CAD CAM graphics and optimization software can be installed in the system.

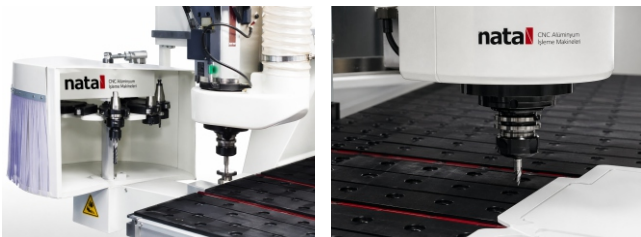

CERTIFICATES

aluminium facade company
Vision of the Polatoglu is to be at every point of construction sector

33

D I F RIETY

Sertifika Certificate

Denetleme Raporu Numarası / Audit Report Number: 10-202108-0002
Sertifika Numarası / Certificate Number: 0445-0000-02320001

POLATOĞLU

Polatoglu Metal Anonim Şirketi

Merkez Adresi: Nispetiye Mah. Uygur İş Merkezi B3, Gazı Döğür Sok. No. 4/9 Beşiktaş / İSTANBUL TÜRKİYE
Azerbaycan Şubesi: Binagadi Baksoi Arzali 1 BAKU / AZERBAIJAN

İli, su ve ses izolasyonu alüminyum doğrama ve panel sistemleri, paslanmaz çelik konstrüksiyonların projelendirilmesi, inşaat, ticaret ve marjinal. Makinalı ekipmanların inşaat, ticaret ve marjinal. İşgah tahliye işleri, iklimlendirme, elektrik ve otomasyon işleri. Endüstriyel tesislerin kurulumu, Alüminyum çelik ve panel sistemlerin tesis, tesis ve otomasyon işleri. Endüstriyel tesislerin kurulumu, Installation of stainless steel construction. Production, trade, and installation of mechanical equipment. Construction concerning air conditioning, electrical and automation work. Installation of mechanical facilities.

TS ISO 45001:2018 İş Sağlığı ve Güvenliği Yönetim Sistemi
Occupational Health and Safety Management System

Mrtsistem'in Bag Denetçi ve Denetçileri tarafından yapılan incelemeler sonucunda, kuruluşun yönetim sisteminin belirlenen faaliyetler kapsamında ilgili standart gereklilikleri karşıladığı gözlemlenmiştir. Bu sertifika, ilgili ölçütüne gerektiren ve Mrtsistem prosedürlerine uyulduğu sürece geçerlidir. As a result of the examinations carried out by Mrtsistem Lead Auditor and Auditors, it was observed that the organization's management system meets the relevant standard requirements within the scope of the specified activities. This certificate is valid as long as the relevant control and Mrtsistem procedures are complied with.

16 Nisan 2021 / 16 April 2021
14 Ağustos 2021 / 14 August 2021

Denetimci / Auditor: Murat Karagözü

İletişim Bilgileri / Contact Information:
Sırtkapı Sokak No: 30, Daire: 22
Etiler / Beşiktaş / İstanbul / Türkiye
+90 532 111 8176
info@mrtsistem.com.tr
www.mrtsistem.com.tr



Sertifika Certificate

Denetleme Raporu Numarası / Audit Report Number: 10-202108-0002
Sertifika Numarası / Certificate Number: 0445-0000-02320001

POLATOĞLU

Polatoglu Metal Anonim Şirketi

Merkez Adresi: Nispetiye Mah. Uygur İş Merkezi B3, Gazı Döğür Sok. No. 4/9 Beşiktaş / İSTANBUL TÜRKİYE
Azerbaycan Şubesi: Binagadi Baksoi Arzali 1 BAKU / AZERBAIJAN

İli, su ve ses izolasyonu alüminyum doğrama ve panel sistemleri, paslanmaz çelik konstrüksiyonların projelendirilmesi, inşaat, ticaret ve marjinal. Makinalı ekipmanların inşaat, ticaret ve marjinal. İşgah tahliye işleri, iklimlendirme, elektrik ve otomasyon işleri. Endüstriyel tesislerin kurulumu, Alüminyum çelik ve panel sistemlerin tesis, tesis ve otomasyon işleri. Endüstriyel tesislerin kurulumu, Installation of stainless steel construction. Production, trade, and installation of mechanical equipment. Construction concerning air conditioning, electrical and automation work. Installation of mechanical facilities.

TS EN ISO 14001:2015 Çevre Yönetim Sistemi
Environment Management System

Mrtsistem'in Bag Denetçi ve Denetçileri tarafından yapılan incelemeler sonucunda, kuruluşun yönetim sisteminin belirlenen faaliyetler kapsamında ilgili standart gereklilikleri karşıladığı gözlemlenmiştir. Bu sertifika, ilgili ölçütüne gerektiren ve Mrtsistem prosedürlerine uyulduğu sürece geçerlidir. As a result of the examinations carried out by Mrtsistem Lead Auditor and Auditors, it was observed that the organization's management system meets the relevant standard requirements within the scope of the specified activities. This certificate is valid as long as the relevant control and Mrtsistem procedures are complied with.

16 Nisan 2021 / 16 April 2021
14 Ağustos 2021 / 14 August 2021

Denetimci / Auditor: Murat Karagözü

İletişim Bilgileri / Contact Information:
Sırtkapı Sokak No: 30, Daire: 22
Etiler / Beşiktaş / İstanbul / Türkiye
+90 532 111 8176
info@mrtsistem.com.tr
www.mrtsistem.com.tr



Sertifika Certificate

Denetleme Raporu Numarası / Audit Report Number: 10-202108-0002
Sertifika Numarası / Certificate Number: 0445-0000-02320001

POLATOĞLU

Polatoglu Metal Anonim Şirketi

Merkez Adresi: Nispetiye Mah. Uygur İş Merkezi B3, Gazı Döğür Sok. No. 4/9 Beşiktaş / İSTANBUL TÜRKİYE
Azerbaycan Şubesi: Binagadi Baksoi Arzali 1 BAKU / AZERBAIJAN

İli, su ve ses izolasyonu alüminyum doğrama ve panel sistemleri, paslanmaz çelik konstrüksiyonların projelendirilmesi, inşaat, ticaret ve marjinal. Makinalı ekipmanların inşaat, ticaret ve marjinal. İşgah tahliye işleri, iklimlendirme, elektrik ve otomasyon işleri. Endüstriyel tesislerin kurulumu, Alüminyum çelik ve panel sistemlerin tesis, tesis ve otomasyon işleri. Endüstriyel tesislerin kurulumu, Installation of stainless steel construction. Production, trade, and installation of mechanical equipment. Construction concerning air conditioning, electrical and automation work. Installation of mechanical facilities.

TS EN ISO 9001:2015 Kalite Yönetim Sistemi
Quality Management System

Mrtsistem'in Bag Denetçi ve Denetçileri tarafından yapılan incelemeler sonucunda, kuruluşun yönetim sisteminin belirlenen faaliyetler kapsamında ilgili standart gereklilikleri karşıladığı gözlemlenmiştir. Bu sertifika, ilgili ölçütüne gerektiren ve Mrtsistem prosedürlerine uyulduğu sürece geçerlidir. As a result of the examinations carried out by Mrtsistem Lead Auditor and Auditors, it was observed that the organization's management system meets the relevant standard requirements within the scope of the specified activities. This certificate is valid as long as the relevant control and Mrtsistem procedures are complied with.

16 Nisan 2021 / 16 April 2021
14 Ağustos 2021 / 14 August 2021

Denetimci / Auditor: Murat Karagözü

İletişim Bilgileri / Contact Information:
Sırtkapı Sokak No: 30, Daire: 22
Etiler / Beşiktaş / İstanbul / Türkiye
+90 532 111 8176
info@mrtsistem.com.tr
www.mrtsistem.com.tr



CERTIFICATE

ISO 9001:2008 Quality Management System

POLATOĞLU METAL ANONİM ŞİRKETİ

Headquarters: Nispetiye Mah. Uygur İş Merkezi Bulvarı Gazı Gücnar Sokak No.4/9 Beşiktaş İSTANBUL, Branch: Binagadi Baksoi Arzali 1 BAKU, AZERBAIJAN

In accordance with NAVIGA procedures, it's hereby certified that the above company applies a management system in line with the above standard for the following scope:

Scope

PROJECTING, MANUFACTURING AND INSTALLATION OF ALUMINIUM WALL AND JOINERY SYSTEMS, INSULATIONS (HEAT, WATER AND NOISE INSULATION), STAINLESS STEEL CONSTRUCTIONS, MANUFACTURING AND INSTALLATION OF MECHANICAL EQUIPMENTS, CONTRACTING OF CONSTRUCTION, AIR CONDITIONING, ELECTRICITY AND AUTOMATION, TURK-KEY INDUSTRIAL PLANTS.

Report No.: 190GE0150 Certificate Expiry Date: 14.09.2018
Certificate Reg. No.: 1643160 First Certification Date: 08.03.2016
This certification has been completed according to NAVIGA's audit and certification procedures and is valid until surveillance audit (03.03.2017).

Certification Body: NAVIGA ULUSLARARASI BELGELENDİRME VE SERTİFİKASYON LTD. ŞTİ.
Mehmet Akif Ersoy Bulvarı No: 10 Kat: 10.01 Beşiktaş / İstanbul / Türkiye
Tel: 0212 482 86 56 Fax: 0212 482 86 57 www.naviga.com.tr - info@naviga.com.tr



CERTIFICATE

ISO 14001:2004 Environmental Management System

POLATOĞLU METAL ANONİM ŞİRKETİ

Headquarters: Nispetiye Mah. Uygur İş Merkezi Bulvarı Gazı Gücnar Sokak No.4/9 Beşiktaş İSTANBUL, Branch: Binagadi Baksoi Arzali 1 BAKU, AZERBAIJAN

In accordance with NAVIGA procedures, it's hereby certified that the above company applies a management system in line with the above standard for the following scope:

Scope

PROJECTING, MANUFACTURING AND INSTALLATION OF ALUMINIUM WALL AND JOINERY SYSTEMS, INSULATIONS (HEAT, WATER AND NOISE INSULATION), STAINLESS STEEL CONSTRUCTIONS, MANUFACTURING AND INSTALLATION OF MECHANICAL EQUIPMENTS, CONTRACTING OF CONSTRUCTION, AIR CONDITIONING, ELECTRICITY AND AUTOMATION, TURK-KEY INDUSTRIAL PLANTS.

Report No.: 190GE0150 Certificate Expiry Date: 14.09.2018
Certificate Reg. No.: 1643160 First Certification Date: 08.03.2016
This certification has been completed according to NAVIGA's audit and certification procedures and is valid until surveillance audit (03.03.2017).

Certification Body: NAVIGA ULUSLARARASI BELGELENDİRME VE SERTİFİKASYON LTD. ŞTİ.
Mehmet Akif Ersoy Bulvarı No: 10 Kat: 10.01 Beşiktaş / İstanbul / Türkiye
Tel: 0212 482 86 56 Fax: 0212 482 86 57 www.naviga.com.tr - info@naviga.com.tr



CERTIFICATE

OHSAS 18001:2007 Occupational Health And Safety Management System

POLATOĞLU METAL ANONİM ŞİRKETİ

Headquarters: Nispetiye Mah. Uygur İş Merkezi Bulvarı Gazı Gücnar Sokak No.4/9 Beşiktaş İSTANBUL, Branch: Binagadi Baksoi Arzali 1 BAKU, AZERBAIJAN

In accordance with NAVIGA procedures, it's hereby certified that the above company applies a management system in line with the above standard for the following scope:

Scope

PROJECTING, MANUFACTURING AND INSTALLATION OF ALUMINIUM WALL AND JOINERY SYSTEMS, INSULATIONS (HEAT, WATER AND NOISE INSULATION), STAINLESS STEEL CONSTRUCTIONS, MANUFACTURING AND INSTALLATION OF MECHANICAL EQUIPMENTS, CONTRACTING OF CONSTRUCTION, AIR CONDITIONING, ELECTRICITY AND AUTOMATION, TURK-KEY INDUSTRIAL PLANTS.

Report No.: 190GE0150 Certificate Expiry Date: 14.09.2018
Certificate Reg. No.: 1643160 First Certification Date: 08.03.2016
This certification has been completed according to NAVIGA's audit and certification procedures and is valid until surveillance audit (03.03.2017).

Certification Body: NAVIGA ULUSLARARASI BELGELENDİRME VE SERTİFİKASYON LTD. ŞTİ.
Mehmet Akif Ersoy Bulvarı No: 10 Kat: 10.01 Beşiktaş / İstanbul / Türkiye
Tel: 0212 482 86 56 Fax: 0212 482 86 57 www.naviga.com.tr - info@naviga.com.tr



CERTIFICATE

Management System as per EN ISO 9001 : 2008

In accordance with TÜV AUSTRIA procedures, it is hereby certified that

POLATOĞLU METAL ANONİM ŞİRKETİ
Headquarters: Nispetiye Mah. Uygur İş Merkezi Bulvarı Gazı Gücnar Sokak No.4/9 Beşiktaş 304 30 İSTANBUL, TURKEY
Branch: Binagadi Baksoi Arzali 1 AZ1053 BAKU, AZERBAIJAN

Applies a Quality Management System in line with the above Standard for the following Scope:

PROJECTING, MANUFACTURING AND INSTALLATION OF ALUMINIUM WALL AND JOINERY SYSTEMS, INSULATIONS (HEAT, WATER AND NOISE INSULATION), STAINLESS STEEL CONSTRUCTIONS, AIR CONDITIONING, ELECTRICITY AND AUTOMATION, TURK-KEY INDUSTRIAL PLANTS.

Certificate Registration No.: 910160154

Initial certification: 2016-03-21
Resuspension Date: 2017-03-21
Valid until: 2017-03-20

Certification Body at TÜV AUSTRIA
Athens, 2016-03-21

This certification was conducted in accordance with TÜV AUSTRIA auditing and certification procedures and is subject to regular surveillance audits. The surveillance audits are mandatory for the re-issuance of the certificate.

TÜV AUSTRIA HELAS
101, Mesogion Ave.,
GR-115 27 Athens, Greece
www.tuv.austria.gr



CERTIFICATE

Management System as per EN ISO 14001 : 2004

In accordance with TÜV AUSTRIA procedures, it is hereby certified that

POLATOĞLU METAL ANONİM ŞİRKETİ
Headquarters: Nispetiye Mah. Uygur İş Merkezi Bulvarı Gazı Gücnar Sokak No.4/9 Beşiktaş 304 30 İSTANBUL, TURKEY
Branch: Binagadi Baksoi Arzali 1 AZ1053 BAKU, AZERBAIJAN

Applies an Environmental Management System in line with the above Standard for the following Scope:

PROJECTING, MANUFACTURING AND INSULATION, STAINLESS STEEL CONSTRUCTION, AIR CONDITIONING, ELECTRICITY AND AUTOMATION, TURK-KEY INDUSTRIAL PLANTS.

Certificate Registration No.: 04016045

Initial certification: 2016-03-21
Resuspension Date: 2017-03-21
Valid until: 2017-03-20

Certification Body at TÜV AUSTRIA
Athens, 2016-03-21

This certification was conducted in accordance with TÜV AUSTRIA auditing and certification procedures and is subject to regular surveillance audits. The surveillance audits are mandatory for the re-issuance of the certificate.

TÜV AUSTRIA HELAS
101, Mesogion Ave.,
GR-115 27 Athens, Greece
www.tuv.austria.gr



CERTIFICATE

Management System as per OHSAS 18001 : 2007

In accordance with TÜV AUSTRIA procedures, it is hereby certified that

POLATOĞLU METAL ANONİM ŞİRKETİ
Headquarters: Nispetiye Mah. Uygur İş Merkezi Bulvarı Gazı Gücnar Sokak No.4/9 Beşiktaş 304 30 İSTANBUL, TURKEY
Branch: Binagadi Baksoi Arzali 1 AZ1053 BAKU, AZERBAIJAN

Applies an Occupational Health & Safety Management System in line with the above Standard for the following Scope:

PROJECTING, MANUFACTURING AND INSTALLATION OF ALUMINIUM WALL AND JOINERY SYSTEMS, INSULATIONS (HEAT, WATER AND NOISE INSULATION), STAINLESS STEEL CONSTRUCTIONS, INSTALLATION OF MECHANICAL EQUIPMENTS, CONTRACTING OF CONSTRUCTION, AIR CONDITIONING, ELECTRICITY AND AUTOMATION, TURK-KEY INDUSTRIAL PLANTS.



EA Scope / Risk category: 17.2 & 18.1 & 20.2 & 34.1.0
Certificate Registration No.: 02016022

Initial certification: 2016-03-21
Resuspension Date: 2017-03-21
Valid until: 2017-03-20

Certification Body at TÜV AUSTRIA
Athens, 2016-03-21

This certification was conducted in accordance with TÜV AUSTRIA auditing and certification procedures and is subject to regular surveillance audits. The surveillance audits are mandatory for the re-issuance of the certificate.

TÜV AUSTRIA HELAS
426 Mesogion Ave.,
GR-115 27 Athens, Greece
www.tuv.austria.gr





CERTIFICATE OF INCORPORATION OF A PRIVATE LIMITED COMPANY

Company Number **10907563**

The Registrar of Companies for England and Wales, hereby certifies that

POLATOGLU METAL LIMITED

is this day incorporated under the Companies Act 2006 as a private company, that the company is limited by shares, and the situation of its registered office is in England and Wales.

Given at Companies House, Cardiff, on **9th August 2017**.

The above information was communicated by electronic means and authenticated by the Registrar of Companies under section 1115 of the Companies Act 2006



Companies House



THE OFFICIAL SEAL OF THE
REGISTRAR OF COMPANIES



Polatoglu Metal Co. Inc.

QUALITY POLICY

Polatoglu Metal Co. Inc. is committed to achieving the highest standards in the field of aluminum facade works. Our primary goal is to enhance customer satisfaction and pursue continuous improvement. The fundamental elements of our quality policy are outlined below:

Customer Focus

Understanding the needs and expectations of our customers is our priority. We aim to provide high-quality products and services, taking customer feedback into account to foster a culture of continuous improvement.

Quality Management

We effectively implement our quality management system in all our processes and strive for continuous improvement. By providing necessary training, we enhance the competencies of our employees to meet quality standards.

Sustainability

We strive to minimize our environmental impact and adopt sustainable practices. We prioritize energy efficiency and waste management in our production processes.

Supplier Collaboration

We collaborate with reliable suppliers to procure quality raw materials and services, regularly evaluating supplier performance.

Continuous Improvement

We continuously review and improve our quality management system. By monitoring our performance indicators, we take necessary actions to achieve our objectives.

This quality policy must be embraced and implemented by all our employees. We are committed to providing all necessary resources to achieve our quality goals and take the required steps for continuous development.

Regards,

ERÇİN POLAT
CEO





MODERN BROCHURE

POLATOĞLU ■■

aluminium facade company
Unite to make planet Earth pollution-free.

Design.
Engineering.
Facades.

■■ **Polatoglu Metal Co. Inc.**

Head Office ISTANBUL

No: 4/9, Uygur Business Center,
Gazi Güçnar St, Nispetiye Nbh, Beşiktaş
İstanbul 34340, Türkiye

T:(+90) 212 337 5787

Corporate Office & Manufacturing Facility | BAKU

World Logistics Center
1C, Lokbatan–Shubani Road
Garadagh District
Baku AZ1000, Azerbaijan

T:(+99) 412 311 1423
WhatsApp Line: (+994) 50 250 2300

E-Mail: info@polatoglu.org

Call Us: *2300

